

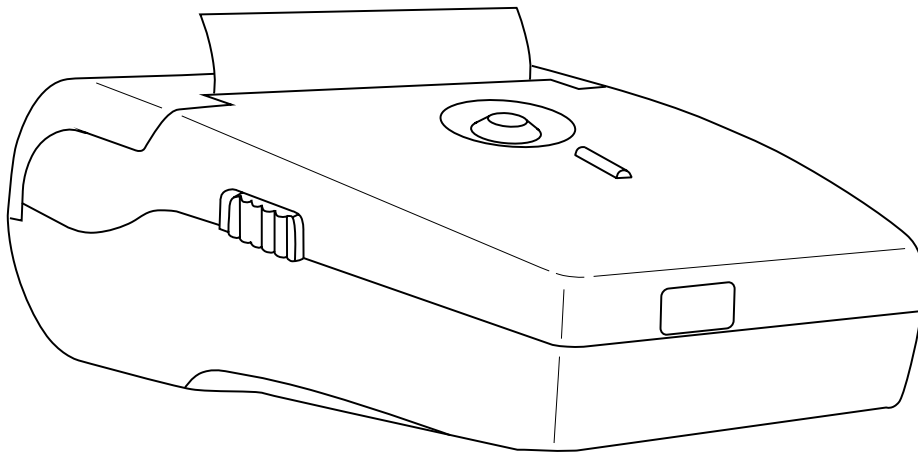

Portable Wireless IrDA Printer
(With Disposable Batteries)
Part No. 0024-1400

Instruction NewHany
Operation & Maintenance

Rev. 1 - March 2014



WARRANTY

Chamjin I&C. warrants to Buyer that at the time of delivery this Product will be free from defects in material and manufacture and will conform substantially to Chamjin I&C's applicable specifications. Chamjin I&C's liability and Buyer's remedy under this warranty are limited to the repair or replacement, at Chamjin I&C's option, of this Product or parts thereof returned to Seller at the factory of manufacture and shown to Chamjin I&C's reasonable satisfaction to have been defective; provided that written notice of the defect shall have been given by Buyer to Chamjin I&C. within six (6) months after the date of delivery of this Product by Chamjin I&C.

Chamjin I&C. warrants to Buyer that it will convey good title to this Product. Chamjin I&C's liability and Buyer's remedy under this warranty of title are limited to the removal of any title defects or, at the election of Chamjin I&C, to the replacement of this Product or parts thereof that are defective in title.

THE FOREGOING WARRANTIES ARE EXCLUSIVE AND ARE GIVEN AND ACCEPTED IN LIEU OF (I) ANY AND ALL OTHER WARRANTIES, EXPRESS OR IMPLIED, INCLUDING WITHOUT LIMITATION THE IMPLIED WARRANTIES OF MERCHANTABILITY AND FITNESS FOR A PARTICULAR PURPOSE: AND (II) ANY OBLIGATION, LIABILITY, RIGHT, CLAIM OR REMEDY IN CONTRACT OR TORT, WHETHER OR NOT ARISING FROM Chamjin I&C'S NEGLIGENCE, ACTUAL OR IMPLIED. The remedies of the Buyer shall be limited to those provided herein to the exclusion of any and all other remedies including, without limitation incidental or consequential damages. No agreement varying or extending the foregoing warranties, remedies or this limitation will be binding upon Chamjin I&C. unless in writing, signed by a duly authorized officer of Chamjin I&C.

Note: *The battery pack is considered a consumable item, and is excluded from the terms of this warranty.*

**Register Your Warranty On-Line by Visiting
www.chamjin.com**

Notice:

Product improvements and enhancements are continuous, therefore the specifications and information contained in this document may change without notice.

Chamjin I&C. shall not be liable for errors contained herein or for incidental or consequential damages in connection with the furnishing, performance, or use of this material.

No part of this document may be photocopied, reproduced, or translated to another language without the prior written consent of Chamjin I&C.

Copyright © 2014, Chamjin I&C, all rights reserved.

Chamjin I&C is a registered trademark of Chamjin I&C.

All other trademarks, trade names, service marks and logos referenced herein belong to their respective companies.

Contents

Description	1
General.....	1
Features	1
Power Switch.....	2
Indicator LEDs	2
Pushbuttons.....	2
Sensors	2
Technical Characteristics	4
Operation.....	5
Precautions.....	5
Self Test.....	5
Set-Up Mode	6
Using the Printer.....	7
Maintenance	8
Battery Installation	8
Paper Installation	8
Cleaning the Printer	10
Cleaning the Print Head	10
Parts & Service	11
Replacement Parts	11
Sales / Service Centers	11

Notes:

Description

General

Chamjin I&C's portable wireless printer uses infrared technology to communicate with other Chamjin I&C instruments that are capable of transmitting data using the Infrared Data Association (IrDA) standard, or HP protocol.

The printer is designed around a patented easy-loading paper mechanism, which consists of a main cavity into which a paper roll is dropped for loading. The thermal print head is at the front of the cavity and a rubber roller is attached to the lid of the mechanism. When the lid is closed, the paper is pinched between the rubber roller and the print-head to give a close alignment and a consistent pressure.

Features

- Wireless printing
- IrDA standard or HP protocol
- Small size
- Quiet, and fast printing
- Direct line thermal printing
- Easy loading paper
- Easy maintenance and head cleaning
- User settable printer parameters using external pushbuttons
- Self-test function

Power Switch

The Power switch, located on the left side of the printer, is used to turn the unit ON and OFF.

Indicator LEDs

- **Power LED (Green):** Glows steady when the printer is turned ON.
- **Error LED (Red):** Flashes once-per-second when the printer is out of paper; the buffer is full; or when the print head temperature exceeds 140°F (60°C). This LED will also flash one time when the printer is placed into its set-up mode (refer to Section *Set-Up Mode*).

Pushbuttons

- **FEED:**
 - Momentarily press this button to advance the paper. Press and hold down to feed paper continuously.
 - This button in conjunction with the ON/OFF switch is used to start the printer's self test function (refer to Section *Self Test*).
 - When the printer is in its set-up mode, this button is used to modify the selected printer parameter (refer to Section *Set-Up Mode*).
- **SEL:**
 - Used in conjunction with the ON/OFF switch to place the printer into its set-up mode (refer to Section *Set-Up Mode*).
 - With the printer in its set-up mode, use this button to select the desired printer parameter.

Sensors

- **Paper Out:** When the paper roll runs out, the printer is disabled to prevent damage to the print head. This condition is indicated by the Error LED flashing red.
- **Infrared Sensor:** Located at the front of the printer, this sensor receives the infrared output of an external instrument.

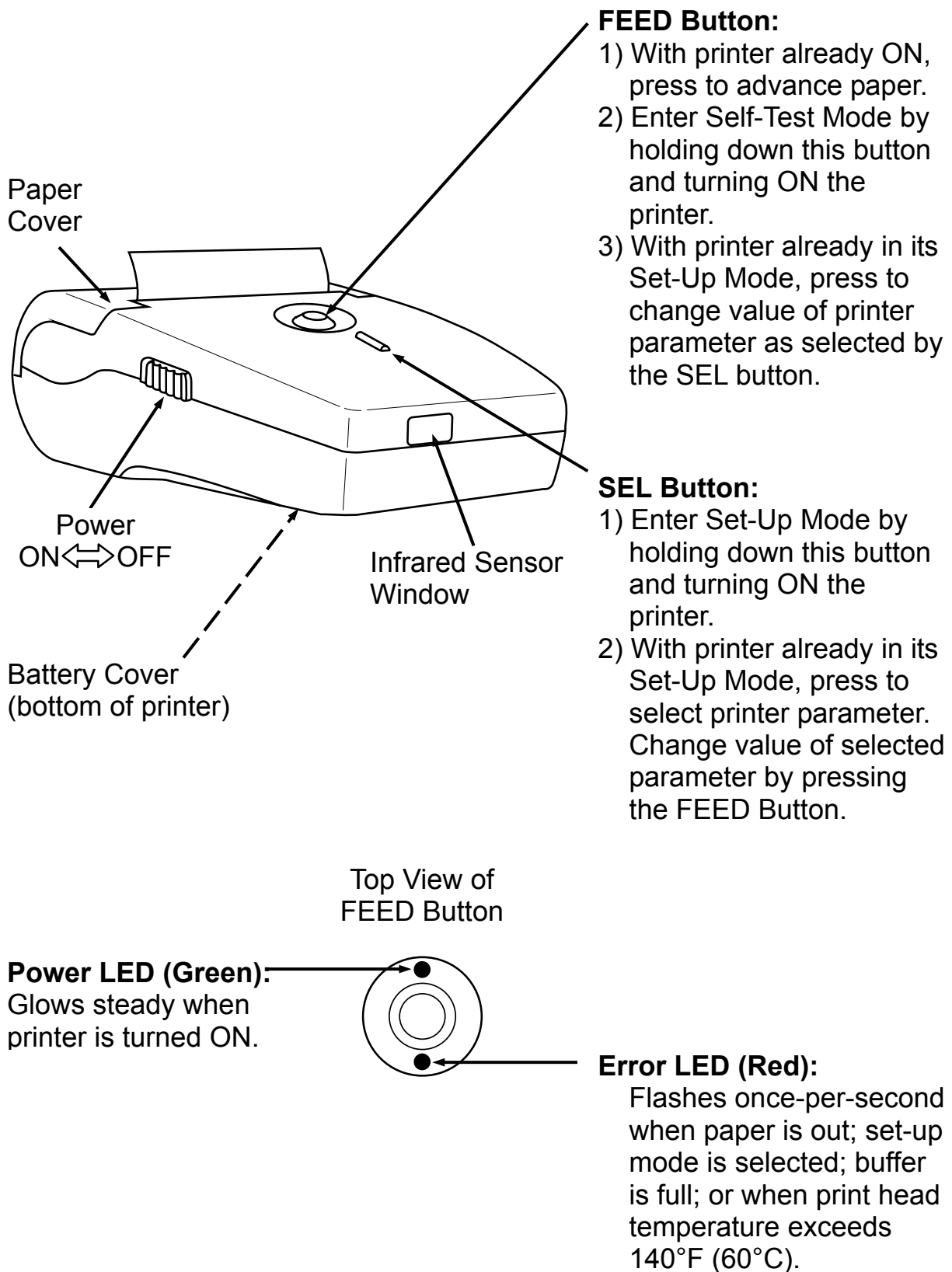

Figure 1. Component Locations and Functions

Technical Characteristics

Printing Method.....	Direct thermal
Number of Columns.....	32, 48 columns, 384 dots/line
Character Size	0.06 x 0.12 in. (1.5 x 3.0 mm)
Line Pitch.....	0.1 in (4.0 mm)
Paper Width.....	2.25 in. (57.5 mm)
Interface.....	IrDA and Serial (RS-232C)
Protocol	IrDA-SIR, HP-Ir, IrDA-Off
International Characters	U.S.A., France, U.K., Denmark I, Sweden, Italy, Spain, Japan, Norway, Denmark II, Korea
Buffer	7 kB
Baud Rate.....	300 ~ 115,200 bps, IrDA: 9,600 ~ 115,200 bps
Power	4'AA'Alkaline Batteries
Weight w/ batteries	0.8 lb (0.4 kg)
Dimensions.....	3.2W x 5.6L x 1.6H in. (81 x 142 x 41mm)

Operation

Precautions

To ensure the proper operation of the printer and prevent the possibility of voiding the warranty, be sure to observe the following precautions:

- Avoid dirty or dusty locations, or those with excessive heat or humidity
- Choose a stable level surface to place the printer
- Use only alkaline batteries
- Use only the supplied thermal paper or its replacement part

Self Test

The self-test mode checks the printer's control circuit functions, setup parameters, software version, and printer quality.

1. Before running the self test, make sure there is sufficient paper to run the test (18" [46 cm]); the paper cover is closed; and that the printer is switched OFF.
2. With the printer initially switched OFF, press and hold down the FEED pushbutton, and then switch ON the printer to begin the test.

Note: *The test can be aborted by switching OFF the printer.*

3. The following typical information is printed, followed by the printer's complete character set:

Version : x.xx
Data bit : 8 bit
Parity : None
Baud rate : 9600 bps
Handshaking : DTR
Country : U.S.A.
Print mode : Text (upright)
Paper : Normal paper
Density : 100%
IrDA : IrDA-SIR
Buffer size : 7000Byte
Head volt : 6.0V
Head temp. : 25°C

Set-Up Mode

The printer has been set up at the factory with the following default parameters:

Baud rate : 9600 bps
 Handshaking : DTR
 Country : U.S.A.
 Print mode : Text (upright)
 Paper : Normal paper
 Density : 100%
 IrDA : IrDA-SIR

If necessary, the default parameters can be changed as follows:

1. With the printer initially switched OFF, press and hold down the SEL pushbutton; and then switch ON the printer.
2. The printer now goes into its set-up mode as indicated by the red LED flashing. At this time all of the printer's current parameter settings are printed, followed by the first parameter that can be modified.

Note: *If no button is pressed within 15 seconds, the set-up mode is automatically terminated without changing the original parameters.*

3. IrDA is first parameter printed. Pressing the FEED button causes the value of that parameter to change in the sequence shown in the following table.

SEL Button	FEED Button
Baud rate	300~115,200
Handshaking	DTR, X-on/X-off
Country	U.S.A., Korea, Cyrillic, Denmark2, Norway, Japanese, Spain, Italy, Sweden, Denmark1, U.K., Germany, France
Print mode	Text(upright), Data(inverted)
Paper	Normal paper, Reprint paper
Density	50~150% in 5% steps
IrDA	IrDA-Off, IrDA-SIR, HP-Ir

4. Press the SEL button to print the next parameter, and then use the FEED button to change that parameter to the desired value.
5. Repeat Step 4 as necessary to change all desired parameters.
6. Once all parameters have been set, press and hold down the SEL button, and then press the FEED button to save the new settings; after which the message "Data Keeping, Setting mode END !!" should be printed.

Using the Printer

see Figure 2. Turn ON the printer and observe that the Power LED should glow green.

Align the printer's infrared sensor to the infrared output of the external instrument. The printer should not be more than 18 inches (45 cm) away from the instrument, at an angle of no more than 30 degrees.

Begin printing as described in the instrument's instruction manual.

Tip: *If the printer does not print, or if random characters are printed, then check that the baud rate and communication protocol (IrDA-SIR or HP-Ir) settings of both the printer and instrument are set to the same values.*

Power LED (Green)

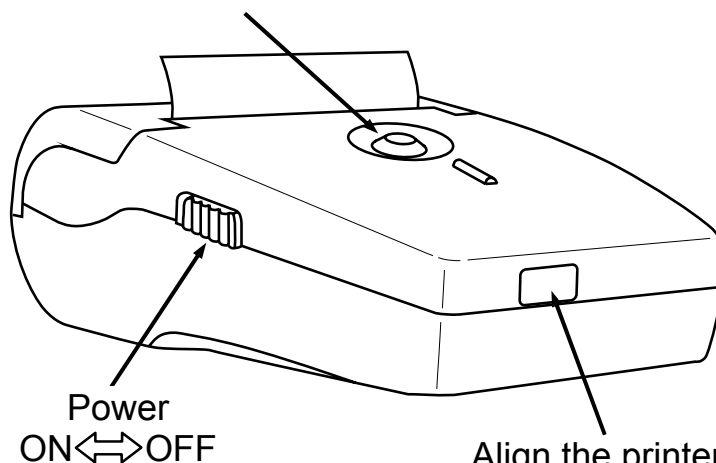

Align the printer's infrared sensor to the infrared output of the external instrument. The printer's sensor should not be more than 18 inches (45 cm) away from the instrument, at an angle of no more than 30 degrees.

Figure 2. Using the Printer

Maintenance

Battery Installation

Install four 'AA' alkaline batteries as follows:

1. Turn OFF printer.
2. Unlatch and remove battery cover from bottom of printer.
3. Remove old batteries and dispose of them properly.
4. Insert four 'AA' alkaline batteries, observing the polarity marked inside the battery compartment.
5. Install battery cover.

Paper Installation

When the printer runs out of paper as indicated by the front panel red LED flashing, install a new paper roll as follows:

1. Lift up paper cover latch, and then open paper cover as shown in Figure 3.
2. Remove spent paper core.
3. Drop in a new paper roll so that it will rotate in the direction shown.
4. Close paper cover so that the paper is pinched between the roller and print head. Remove any slack by pulling out about ½ inch of paper from printer.

Note: *If there was unprinted data in memory when the paper ran out, and the printer was not shut OFF, then the printer will automatically print the remaining data 5 seconds after closing the paper cover.*

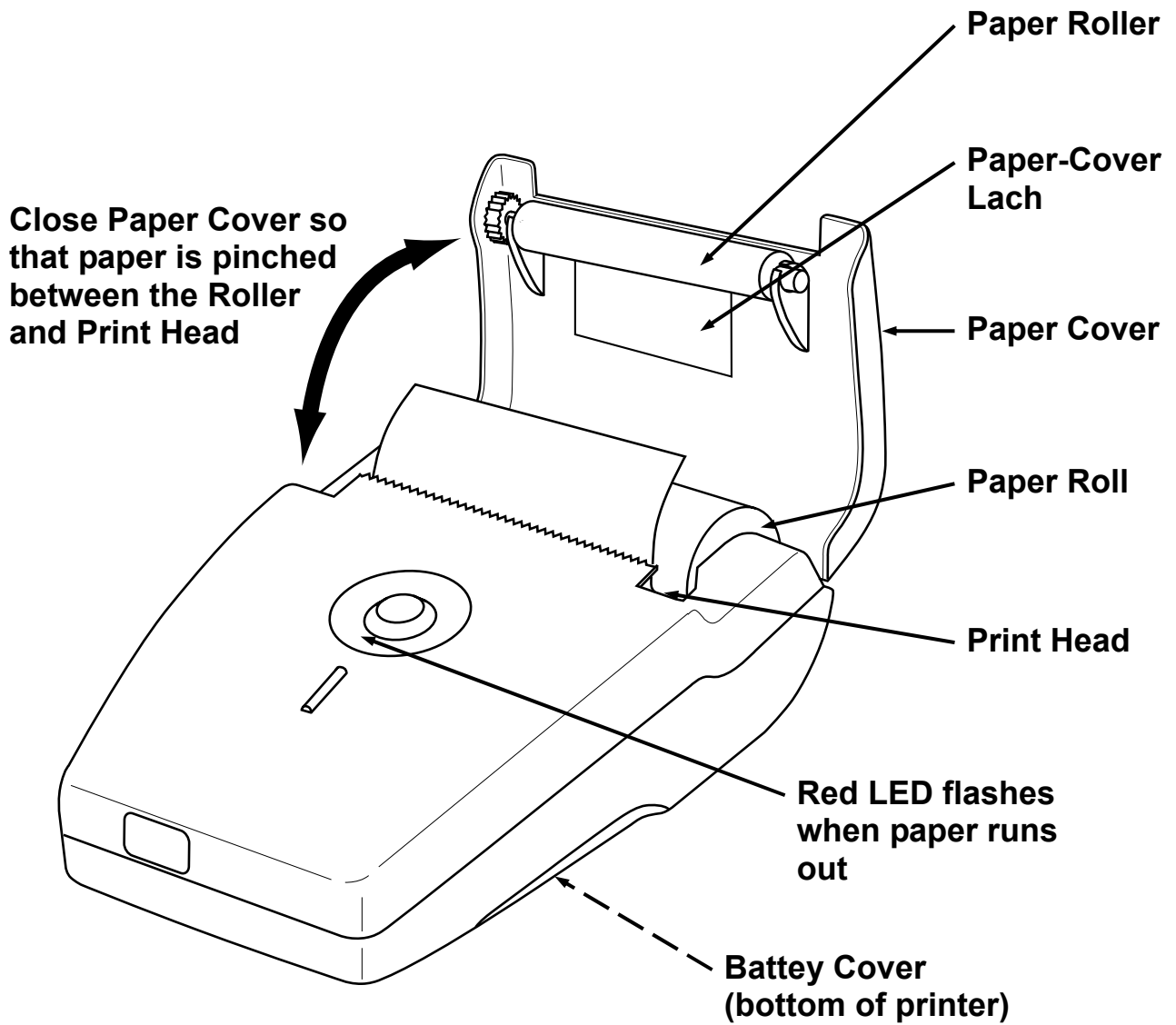

Figure 3. Maintenance

Cleaning the Printer

External surfaces of the printer may be kept clean by simply wiping with a damp cloth. Do not use any solvents that may attack the plastic case. Be sure that the inside surfaces are kept dry at all times.

Cleaning the Print Head

To maintain a good print quality, it is recommended that the print head be cleaned at least once a year or up to once a month if the printer is used heavily. The print head should be cleaned immediately, however, if the print becomes visibly fainter due to contamination of the print head.

Material Required:

- Isopropyl Alcohol
- Cotton swabs

Procedure:

1. Switch OFF printer.



CAUTION: *Allow the print head to cool before cleaning, otherwise damage to the print head may occur.*

2. Open paper cover and remove paper roll.
3. Using a cotton swab dampened with alcohol, wipe the heating dots of the print head. *Be careful not to touch the heating dots with your fingers.*
4. Allow the alcohol to dry.
5. Reload the paper and close the paper cover.

Parts & Service

Replacement Parts

	Part No.
Paper, thermal:	
1 roll	06-8733
5 roll pack.....	24-1230
Battery Cover.....	24-1310

Sales / Service Centers

Chamjin I&C in USA

ADDRESS : 2411 Oak Valley Dr #500, Ann Arbor, MI 48103
TEL : 1-248-202-0777
FAX : 1-248-230-9542
E-mail : jaejung@globalinkllc.net

3F, OSUNG BUILDING, #1024, HWAGOK-DONG,
KANG SEO-KU, SEOUL, KOREA
Phone: (822)2601-9882 • Fax: (822)2601-9883
Website: www.chamjin.com • E-mail: chamjin@chamjin.com

Printed in Korea

